

Cypress Creek Mobility Hub Master Plan



Progress Meeting

April 10, 2015

Presentation Structure

- Draft Area Concept Plan
 - Land Use
 - Mobility
 - Urban Design
- Draft Site Plan Concepts
 - Goals
 - Assumptions
 - Considerations
- SFRTA Site Development Program Options



Draft Area Concept Plan

Long term, area-wide concept

“Synergy” opportunities for station, site and broader area

Mutually supportive public and private investments

Land Use

- “Quadrants” served by shared parking and retail nodes/clusters
- Transit-supportive retail to primary uses, demand will grow over time for retail “infill”
- Clustered retail uses can share parking/signage
- Include amenities for residents/workers/visitors (plazas, recreational spaces)

Draft Area Concept Plan

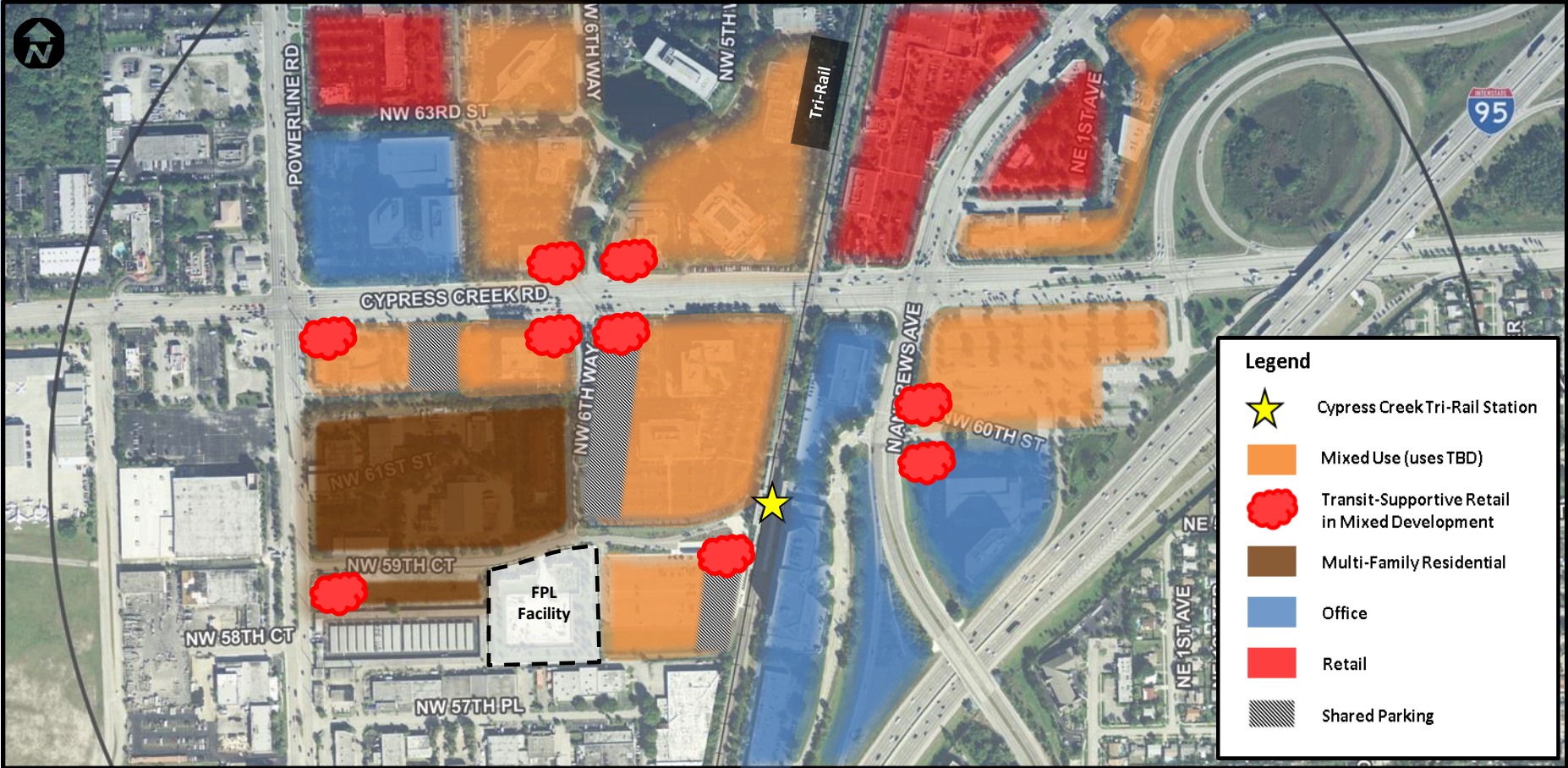

Draft Area Concept Plan

Mobility

- Ped/bike mobility within “quadrants” with designated locations for safe crossings between
- Accommodate curb-side bus stop facilities, tied to Tri-Rail via improved pathways
- Relocate I-95 interchange connection to east of Andrews

Urban Design

- Common streetscape and wayfinding elements to “brand” the Uptown area (*prototypes*)
- Boost the “presence” of the Tri-Rail station
- Establish a transit-friendly zone between Andrews and Powerline, and south to Andrews Way

Potential Public Investments

“Menu” of investments may include...

- Pedestrian connection from Cypress Creek Tri-Rail Station platform to Cypress Creek Rd.
- “Gateway” and crossing improvements at:
 1. Cypress Creek, mid-block near tracks
 2. Cypress Creek and NW 6th Way
 3. Powerline and NW 59th Ct
 4. Cypress Creek and Andrews Ave
 5. Andrews Avenue and Andrews Way



Potential Public Investments continued...

- Sidewalks and lighting at station approaches
- Amenities/wayfinding at new stop/transfer locations
- Bicycle parking facilities at station/garage
- Participation in garage construction
 - ✓ Commuter parking spaces
 - ✓ Car sharing
 - ✓ Car charging stations



Draft Site Plan Concepts

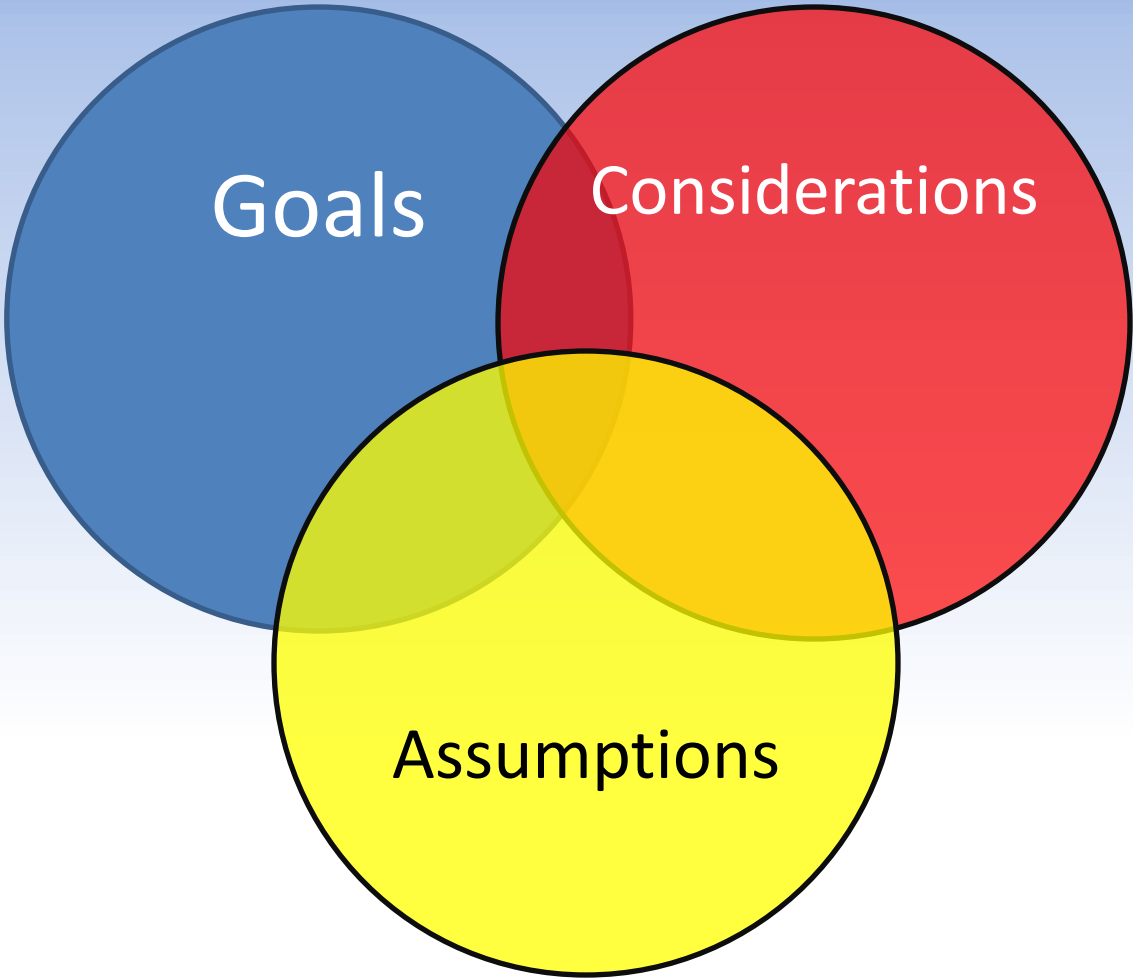

Goals

- Enhance area land use mix
- Maximize opportunities for shared parking
- Reduce visual impact of parking
- Use parking structure as a buffer
- Improve access to the Tri-Rail station
- Improve views to the Tri-Rail station
- Establish strong station area identity/image

Assumptions

- Zoning
 - ✓ Zoning-related use restrictions will be resolved
 - ✓ Zoning category will allow for development flexibility
- Utilities
 - ✓ New utilities will be brought in from Powerline Road to service the site
- Land Use
 - ✓ Amendment to be processed and approved by the City and County

Considerations

- Site context / conditions
 - ✓ Aesthetic, attractiveness, and functional requirements
- Land area availability
- Maximum allowable building height
- Site drainage
 - ✓ Broward County Development and Regulations Department
- Parking requirements
 - ✓ Transit
 - ✓ Future land uses

Site Context Conditions

- Cypress Creek Station
- University of Phoenix
- Extended Stay Hotel
- Industrial Area
- FPL Storage
- Fort Lauderdale Executive Airport
- Offices

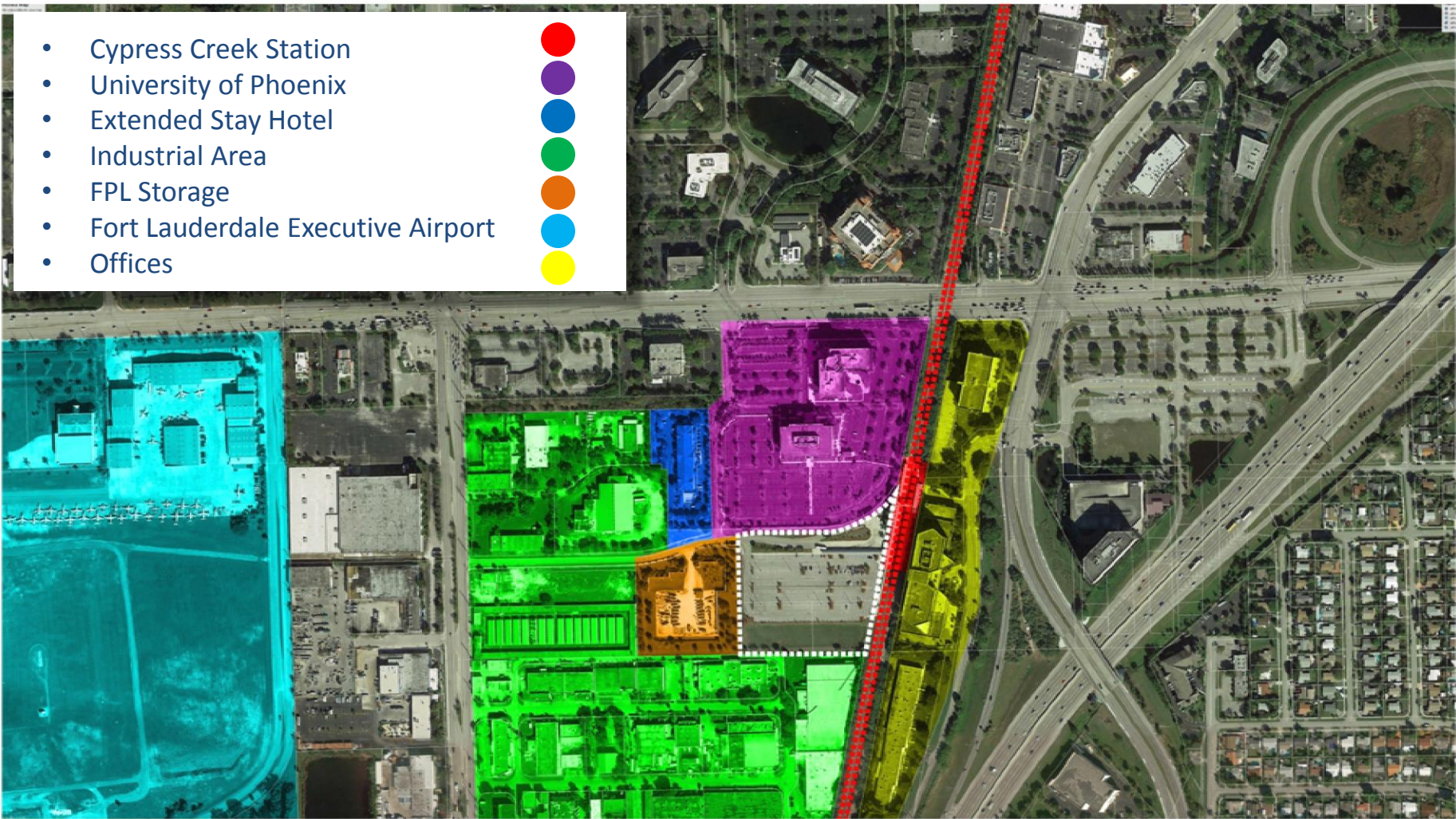

Land Area Availability

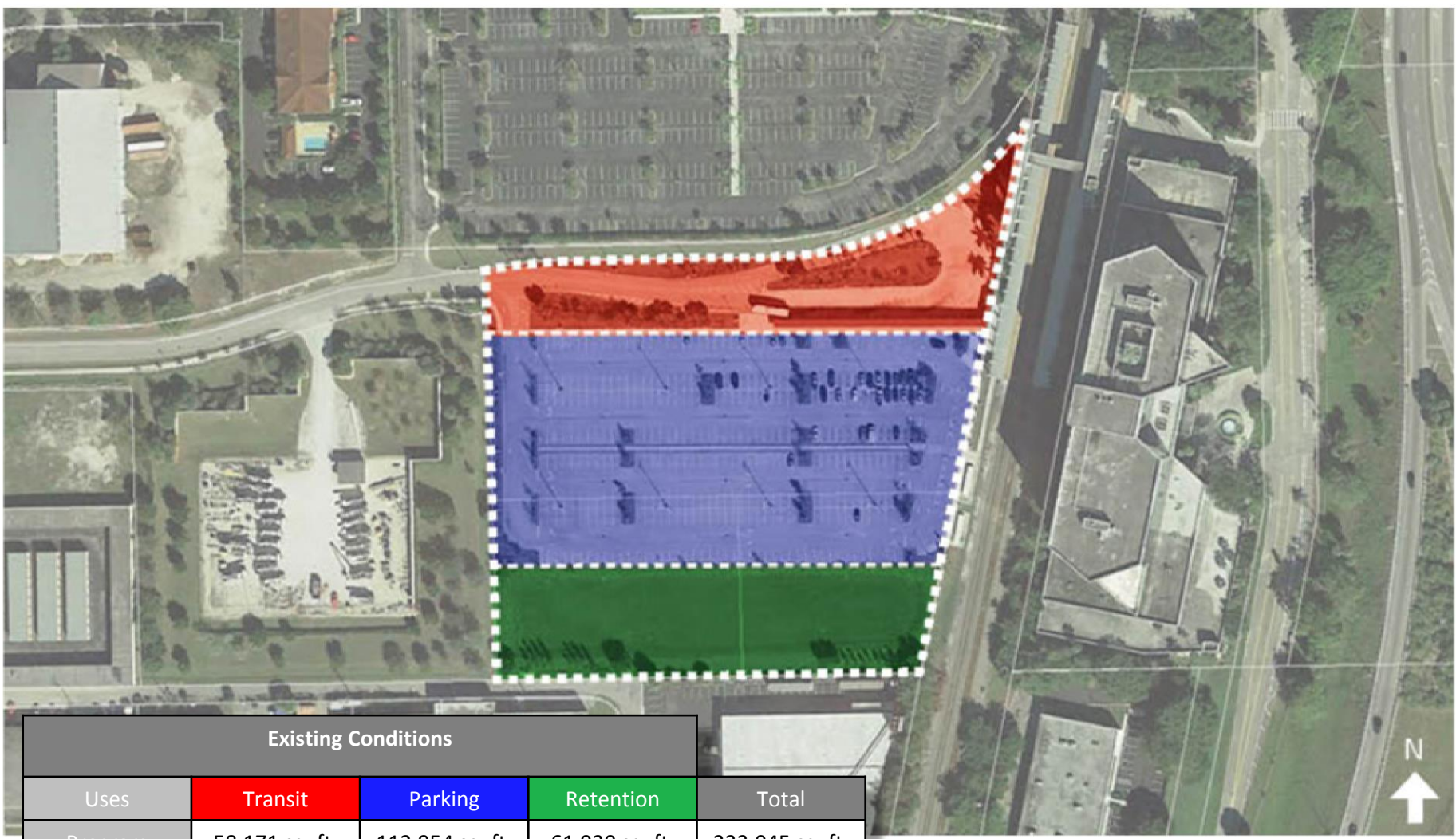

Existing Conditions				
Uses	Transit	Parking	Retention	Total
Program Area	58,171 sq. ft.	112,954 sq. ft.	61,920 sq. ft.	233,045 sq. ft.
	1.3 acres	2.6 acres	1.4 acres	5.3 acres

Land Area Availability

- Suggest maintaining vehicle entrance area
 - ✓ Provides sense of arrival
 - ✓ Maintain views of station
 - ✓ Visually and functionally opens station to future development
 - ✓ Allows for convenient drop-off
 - ✓ Can be located within parking structure per SFRTA
 - ✓ Additional area available for development

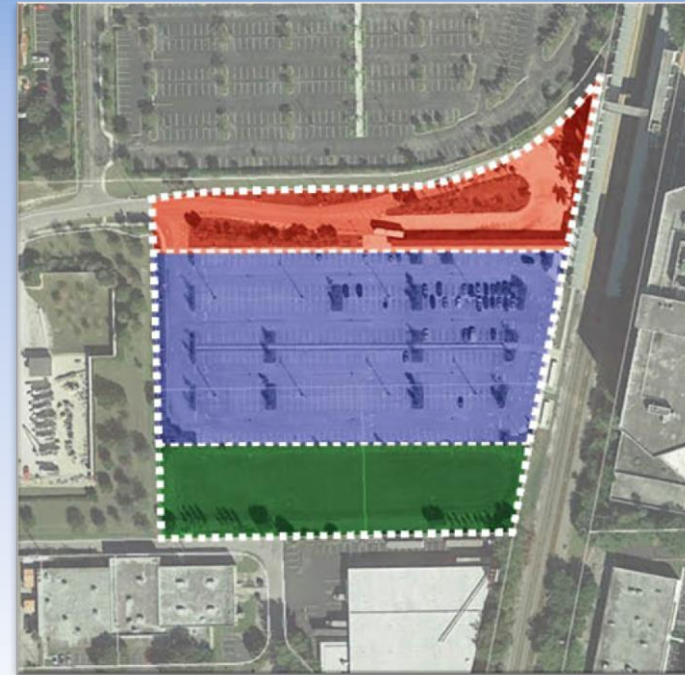

- Existing parking area as buildable site area (blue)
- Retention area as both drainage and open space (green)
 - ✓ Buffer to industrial uses
 - ✓ Zoning open space requirements

Maximum allowable building height

Maximum Allowable Building Height: 100'



Staff from the Fort Lauderdale Executive Airport has estimated that the maximum building height for development on the SFRTA property is limited to 100', so as to not interfere with the glide path for airplane operations at FXE.

Site Drainage



Existing Conditions	
Uses	Retention
Program Area	61,920 sq. ft.
	1.4 acres

Site Drainage

From the Broward County Storm Water Permit and Drainage Report for the site:

- Discharge Area
 - ✓ Site has no offsite discharge...drainage is completely self-contained
 - ✓ Site does not receive storm water from the neighboring areas
- Site handles storm water with
 - ✓ Dry retention pond
 - ✓ Site grading (green area south of the pond)
 - ✓ Pavement storage within the existing parking lot
- Limitations
 - ✓ Drainage wells
 - ✓ Cannot be used on this site
 - ✓ Ex-filtration trenches
 - ✓ Effective use of ex-filtration trenches not suitable based on site percolation tests

Site Drainage Potential Solutions

- Site was designed for a 25 year flood event
- Broward County requires only a 5 year flood event design
 - ✓ Provides an opportunity for reduction in the amount of required retention area
- Parking structure could be located over retention area
 - ✓ Elevated on piles or cantilever
 - ✓ Maintenance program approved by Broward County
 - ✓ Allows maximization of site land area

Transit Parking

Existing Conditions	
Uses	Parking
Program Area	112,954 sq. ft.
	1.4 acres

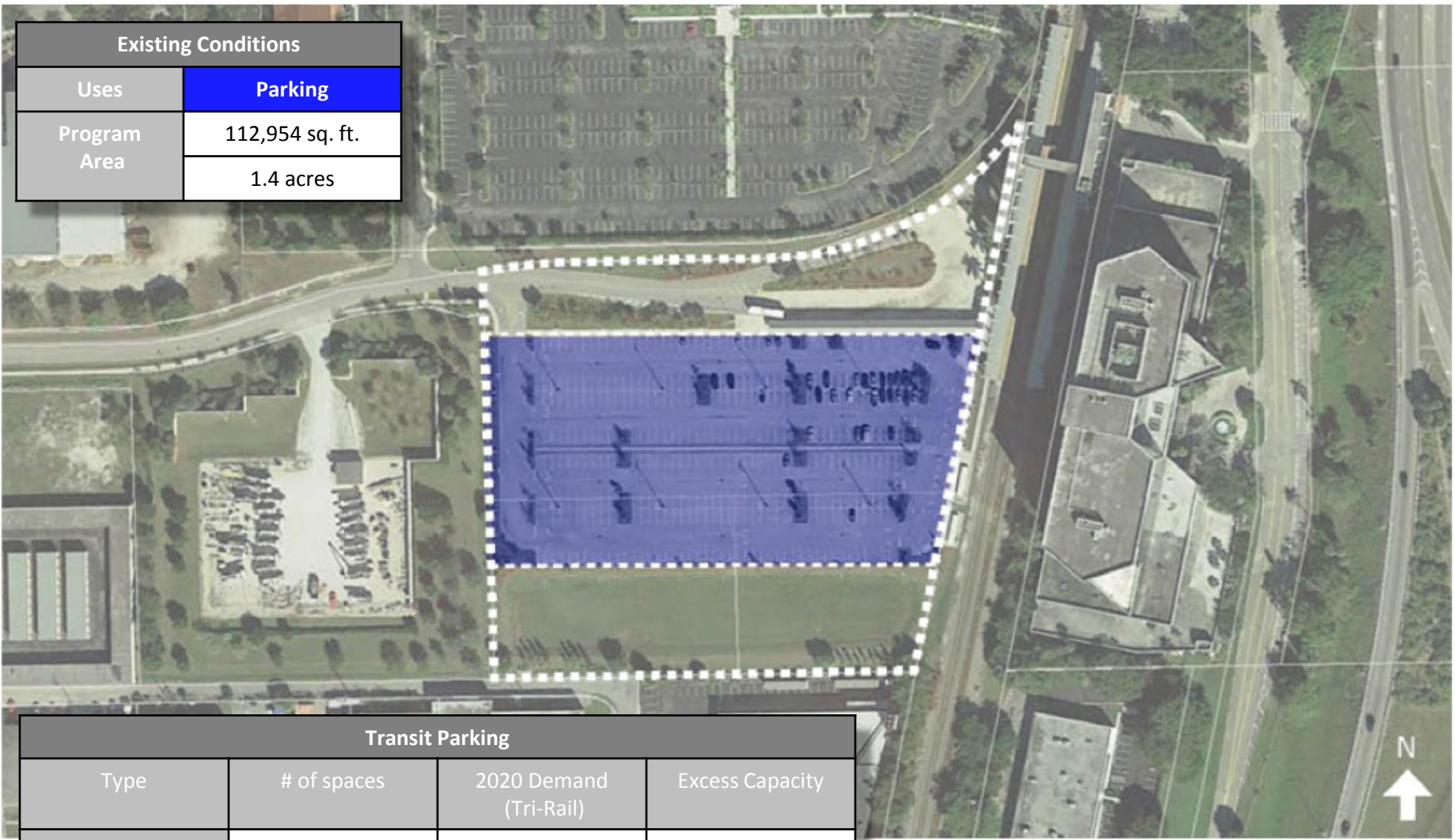

Transit Parking			
Type	# of spaces	2020 Demand (Tri-Rail)	Excess Capacity
Surface Area	345	250	95

Parking – Future Land Uses

- Fort Lauderdale, Florida - **Unified Land Development Code (Section 47-20)**
 - ✓ Residential: (1.75/1 BR Unit) (2/2 BR Unit) (2.1/3 BR Unit)
 - ✓ Office: 1/250 sq.ft. gfa
 - ✓ Hotel: 1/room
 - ✓ Retail : 1/250 sq.ft.
- ULDC shared parking provisions:
 - ✓ Parking reduction
 - ✓ Shared parking alternatives
 - ✓ Criteria and review process required
- Developer requirements
 - ✓ Minimum number of spaces to secure financing

Shared Parking Potential

- Consider using excess transit capacity (95 spaces) towards new use(s)
- Apply shared parking factors based on a 'smart growth approach'
- Peak demand period varies by use
 - ✓ Apply shared factor of **30%** Residential to Commuter
 - ✓ Apply shared factor of **30%** Hotel to Commuter
 - ✓ Apply shared factor of **10%** Office to Commuter

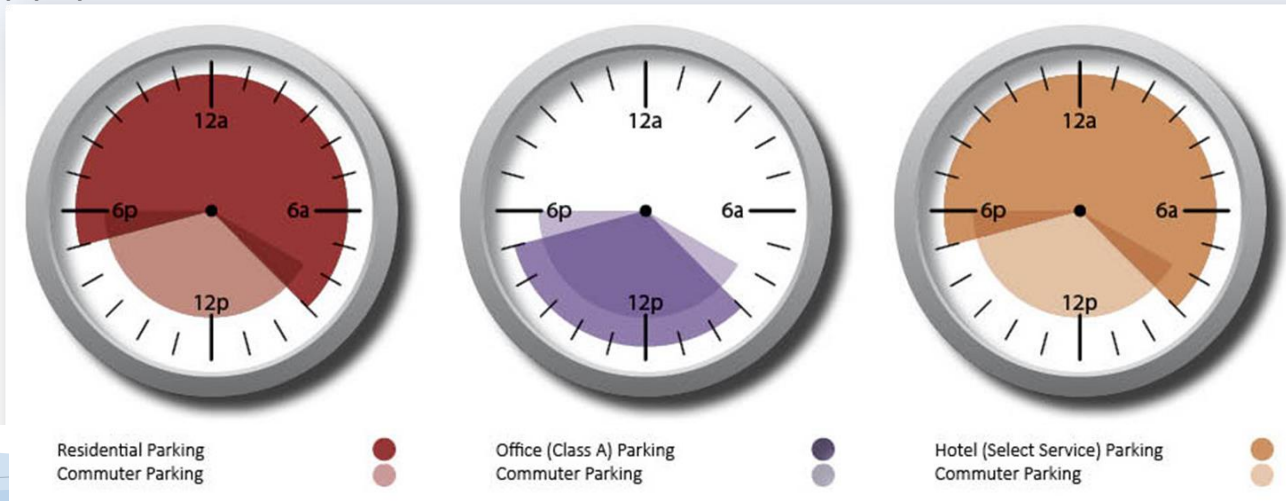

Summary of Potential Solutions

- Context
 - ✓ Optimize location of uses
 - ✓ Preserve views of station
 - ✓ Maximize visibility of proposed uses
- Land area availability
 - ✓ Maximize land area through innovative retention solution
 - ✓ Optimizing building layout and parking
- Meet allowable height of 100 feet
- Drainage
 - ✓ Reduction of retention requirement from 25 year to 5 year flood design
- Parking
 - ✓ Utilize excess capacity of 95 spaces
 - ✓ Allow for shared parking

Minimum build out:
No parking structure

Minimum Build-out Options

What can be built on the site without any structured parking?

- Maintain 250 surface spaces for commuter uses
- Minimize footprint of proposed uses
 - ✓ Building on piles
 - ✓ Limit loss of 95 excess capacity parking spaces

Minimum Build-out Options (No shared parking)



RESIDENTIAL

- 46 units
- Total parking requirement = 92
 - Less than the 95 excess available



OFFICE

- 20,000 sq. ft
- Total parking requirement = 80
 - Less than the 95 excess available



HOTEL

- 90 rooms
- Total parking requirement = 90
 - Less than the 95 excess available

Minimum Build-out Options (Shared parking)

- Office or Residential not possible with surface parking only
 - ✓ Required building footprint eliminates 250 commuter parking spaces
 - ✓ High parking demand exceeds surface parking capacity
- Hotel with surface parking possible
 - ✓ Aggressive shared parking ratio (85-90%)
 - ✓ Requires acceptance by SFRTA, City of Fort Lauderdale, and future developer

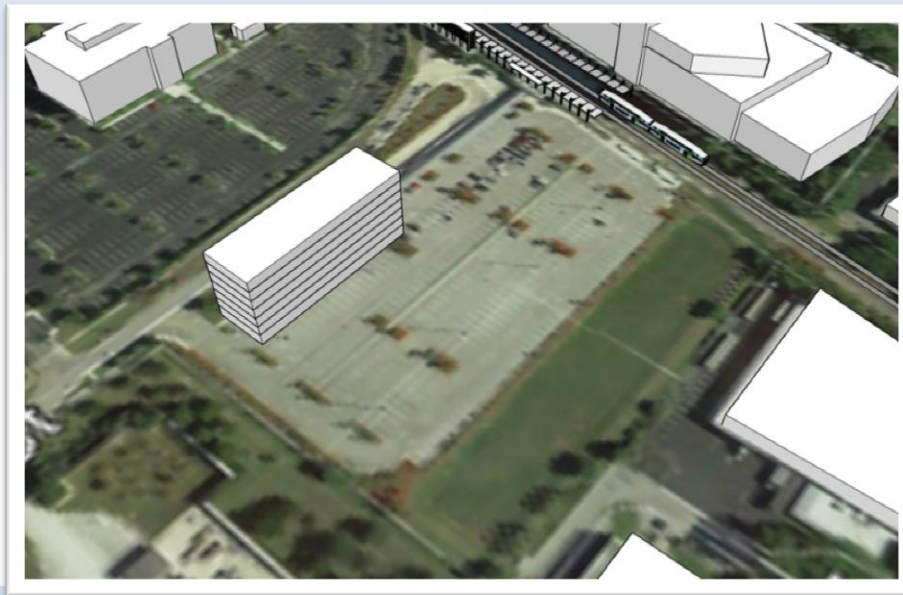

150 rooms = 150 spaces needed
150 spaces * .85 reduction = 25 spaces
dedicated for hotel

Summary of Minimum Build-out Options

- Surface parking options limit development potential
- Hotel with surface parking possible
- Parking structure integral for most development scenarios
- Parking structure maximizes development scenarios
 - ✓ For mixed uses
 - ✓ For single use

Maximum Build-out Option

Maximum Build-out Option

- Deck the totality of the existing surface parking area
 - ✓ Provide two levels of parking on total footprint
- Amenity deck on parking structure
 - ✓ Recreation uses - open space for residential and hotel
- Dry retention area remains intact
 - ✓ Parking structure to partially project over retention
 - ✓ Maintains buffer to industrial area
- Mixed use based on Market Study
 - ✓ 150 hotel rooms
 - ✓ 200 residential units
 - ✓ Transit-supportive retail

Maximum Build-out Option

- Hotel at front of site
 - ✓ Provides high visibility
 - ✓ Buffers parking use
 - ✓ Allows access at grade
- Residential towards rear
 - ✓ Access to amenity deck
 - ✓ Buffered from industrial area on rear
 - ✓ Allow vehicular access at grade
- Provide transit-supportive retail at street level
- Use smart growth shared parking approach (hotel/residential – 30%)
 - ✓ Residential – 280 spaces
 - ✓ Hotel – 105 spaces
 - ✓ Commuter – 250 spaces
 - ✓ Retail – 40 spaces
 - ✓ **TOTAL – 675 spaces needed**

Maximum Build-out Option

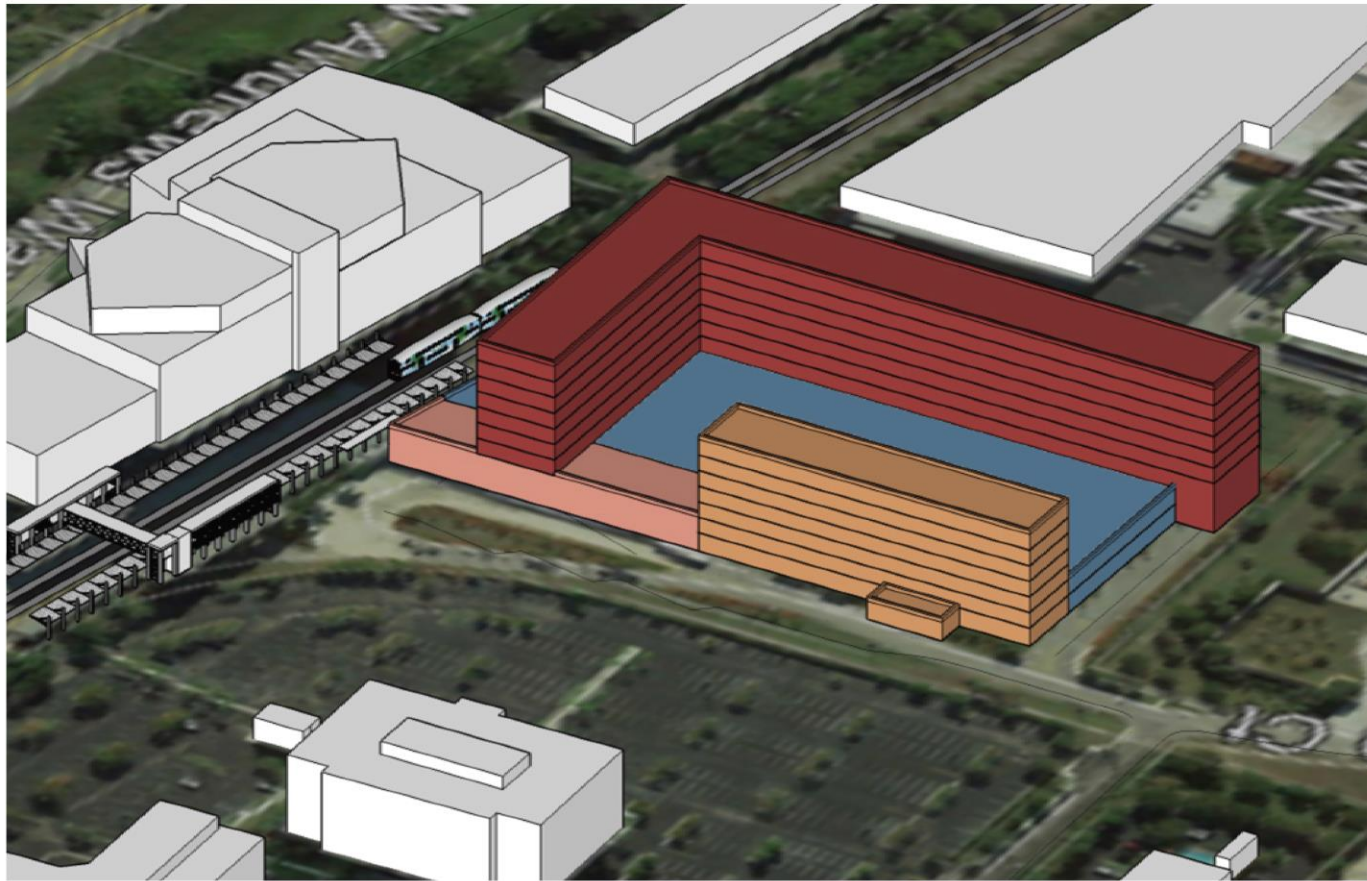

- Residential
(7 stories above parking deck and 200 units)
- Hotel
(7 stories above parking deck and 150 rooms)
- Transit-Supportive Retail
- Parking
(2 stories and 750 spaces)

Summary of Maximum Build-out Option

- Maximizes use of land resources
- Provides for significant density
- Constructed as one project
 - ✓ Substantial initial investment
- Difficult to phase construction and maintain commuter parking use
- Cost considerations
 - ✓ Higher cost of parking structure
 - ✓ Higher cost of residential and hotel uses

Alternate Development Options

Alternate Development Options

- Independent parking structure

- ✓ Ability to meet height restriction
- ✓ Ability to phase construction of multiple uses
- ✓ Less costly

- Integrated parking structure

- ✓ Building constructed over parking
- ✓ FXE height restriction (100') limits ability to stack development
- ✓ Construction phasing becomes difficult
- ✓ Higher costs

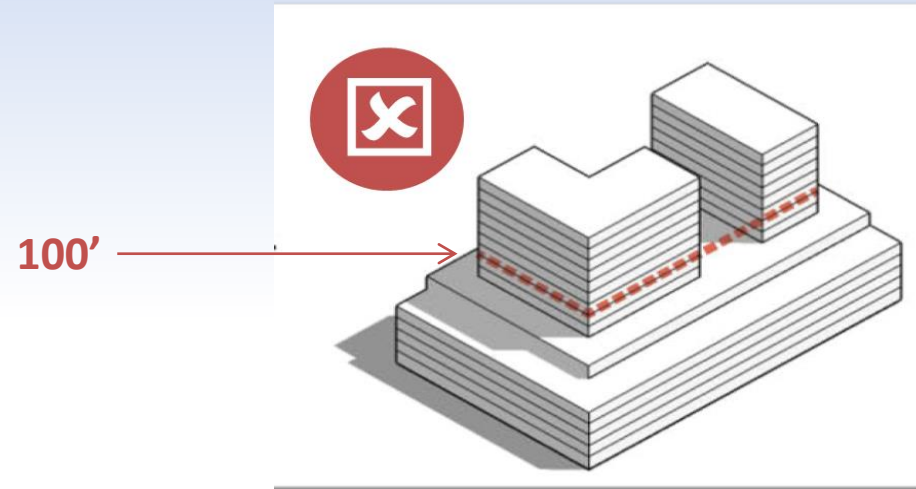
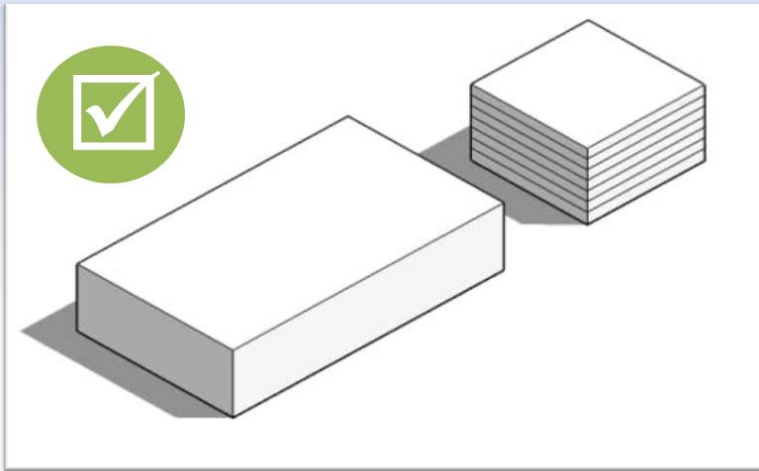

Alternate Development Options

- Integrated parking structure will exceed FXE allowable height limit
 - Parking demand for any singular use approaches FXE height limit

Use	Site Concept
Residential	200-250 rental apartments
Office	125,000 - 150,000 ± sq.ft.
Hotel	150 rooms

	Parking Structure		
	Demand	2-Bay	3-Bay
Residential	600 spaces	6 floors	4 floors
Office (Class A)	790 spaces	7 floors	5 floors
Hotel (Select Services)	355 spaces	4 floors	3 floors

* Assumes shared parking reduction and use of excess 95 spaces

Alternate Development Options

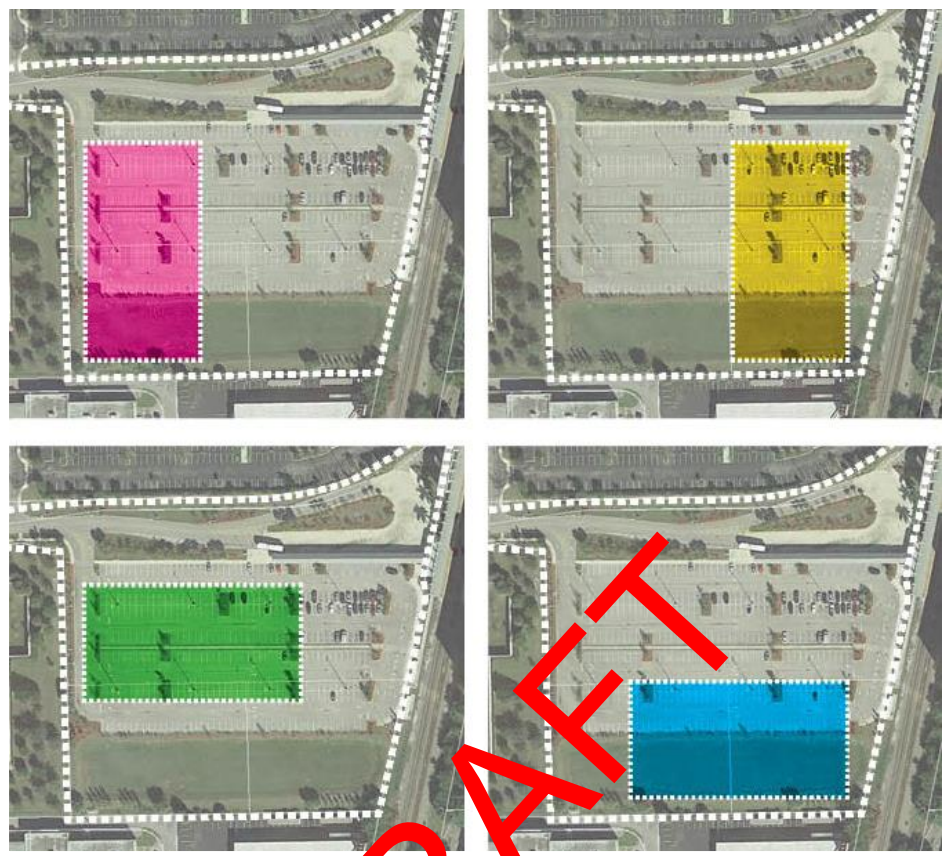

- Yes
- No

DRAFT

The parking structure should...				
	Alternative 1	Alternative 2	Alternative 3	Alternative 4
Prioritize the future development for the site.	<input checked="" type="radio"/>	<input checked="" type="radio"/>	<input type="radio"/>	<input checked="" type="radio"/>
Buffer any proposed development on the site, from the train. (noise and vibration)	<input type="radio"/>	<input checked="" type="radio"/>	<input type="radio"/>	<input type="radio"/>
Allow access for pedestrians, vehicles and public transportation.	<input checked="" type="radio"/>	<input checked="" type="radio"/>	<input checked="" type="radio"/>	<input checked="" type="radio"/>
Minimize impact of new street/driveway to access parking and building development.	<input checked="" type="radio"/>	<input checked="" type="radio"/>	<input checked="" type="radio"/>	<input type="radio"/>
Provide close connections for commuters to the station.	<input type="radio"/>	<input checked="" type="radio"/>	<input type="radio"/>	<input type="radio"/>
Separate access points for commuters to the station and the development.	<input type="radio"/>	<input checked="" type="radio"/>	<input type="radio"/>	<input type="radio"/>
Preserve current square footage for retention.	<input checked="" type="radio"/>	<input checked="" type="radio"/>	<input checked="" type="radio"/>	<input checked="" type="radio"/>
Be visible form the street and the station.	<input checked="" type="radio"/>	<input checked="" type="radio"/>	<input checked="" type="radio"/>	<input type="radio"/>
Be compatible with an improved image/identity for the station and surrounding area.	<input checked="" type="radio"/>	<input checked="" type="radio"/>	<input checked="" type="radio"/>	<input checked="" type="radio"/>

Alternate Development Options: Mixed Use

	A	B	C	D	E	F	G	H	
Use Type	Market Analysis Absorption	Parking Req't by Code	Parking Demand by Code	Present Surface Parking Count	SFRTA Lot 2020 Parking Demand (Tri-Rail)	2020 Excess Capacity $= (D+E)$	Shared Parking Factor	Shared Parking Reduction (Spaces) $= C \times G$	Required Structured Parking Spaces $= C+D-F-H$
Residential	126 units	2 per unit (avg.)	252 spaces				30%	75.6	176 spaces
Office	69,000 sq.ft.	1/250 sq.ft.	276 spaces	345 spaces	250 spaces	95 spaces	10% reduction	27.6 spaces	498 spaces
Total Parking Spaces Required									674

- ✓ 498 Spaces required for Commuter and Office Parking with 10% shared parking factor
- ✓ 176 spaces required for residential with 30% shared parking factor
- ✓ Assumes limited retail (10,000 sq.ft.) parking will be supplied by the two parking decks

Alternate Development Options: Mixed Use

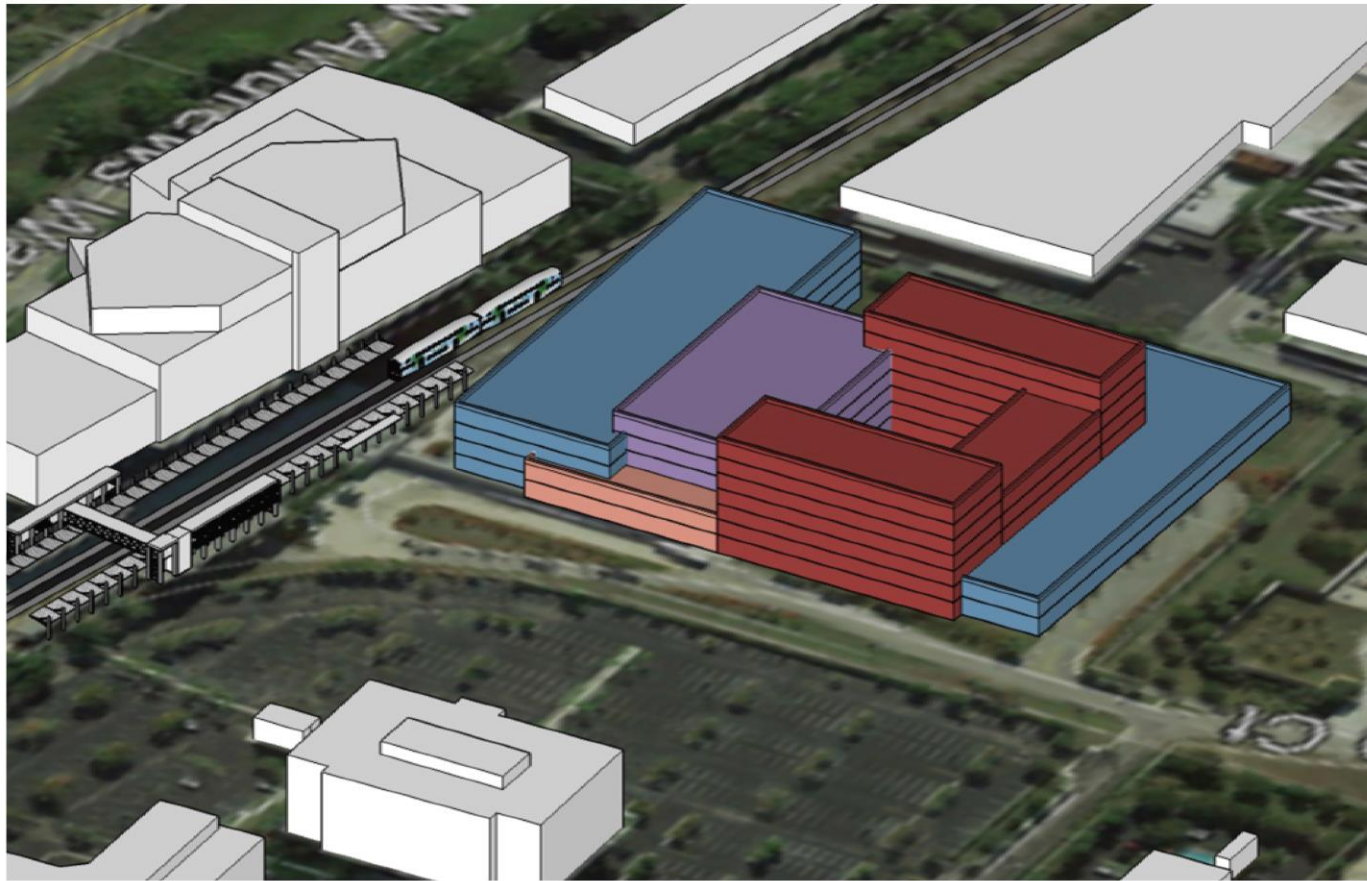

- Residential
(7 stories above parking deck and 126 units)
- Office
(4 stories and 69,000 sq.ft.)
- Transit-Supportive Retail
(10,000 sq.ft.)
- Parking
2 structures needed to meet demand

Structure 1
(4 stories and 498 spaces)

Structure 2
(2 stories and 244 spaces)

Alternate Development Options: Mixed Use

- Physical constraints of site area and maximum height limits may not accommodate mixed uses
- Need for two parking structures
- Development density of the mixed uses is limited

Alternate Development Options: Residential

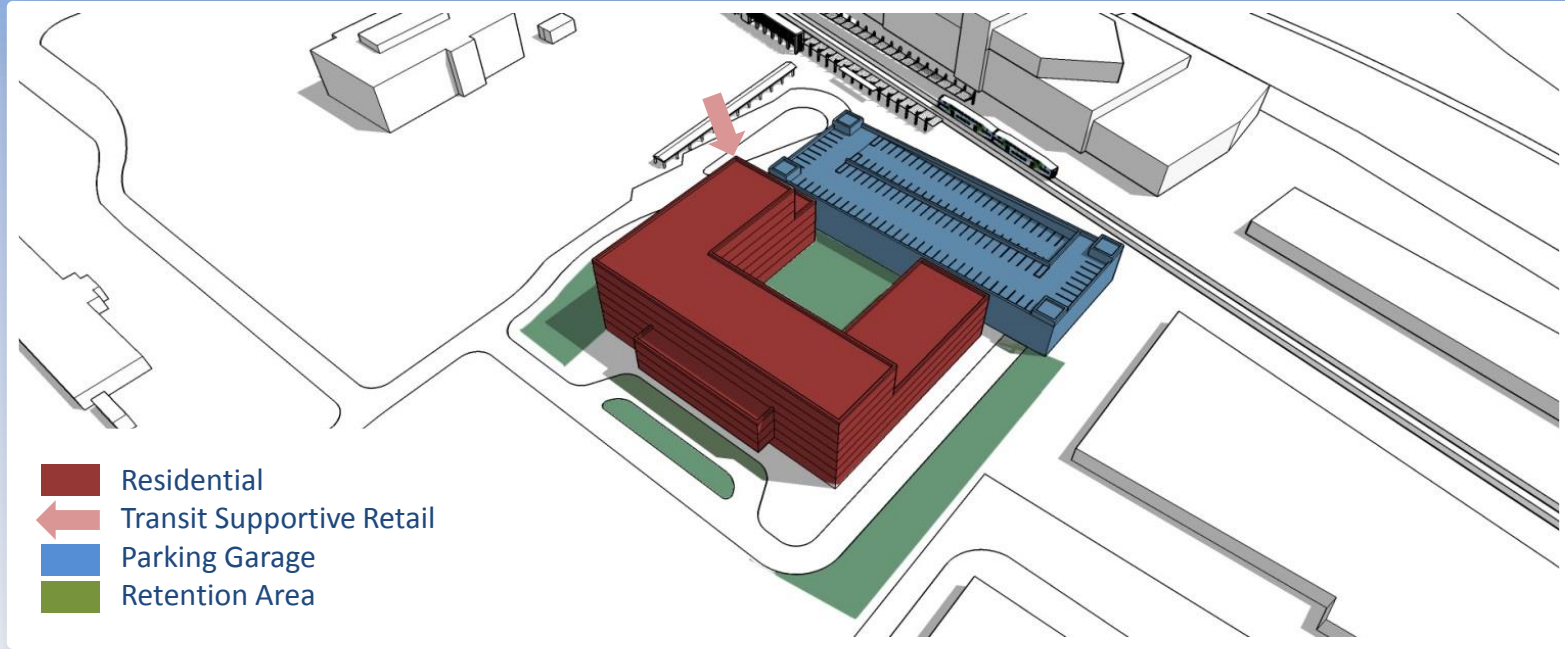

- Market Study calls for 250 units
 - ✓ 38 units/acre
- Building Height – 7 floors
- 600 total spaces needed
 - ✓ Includes commuter and residential demand
 - ✓ Assumes 30% shared parking reduction

Alternate Development Options: Office

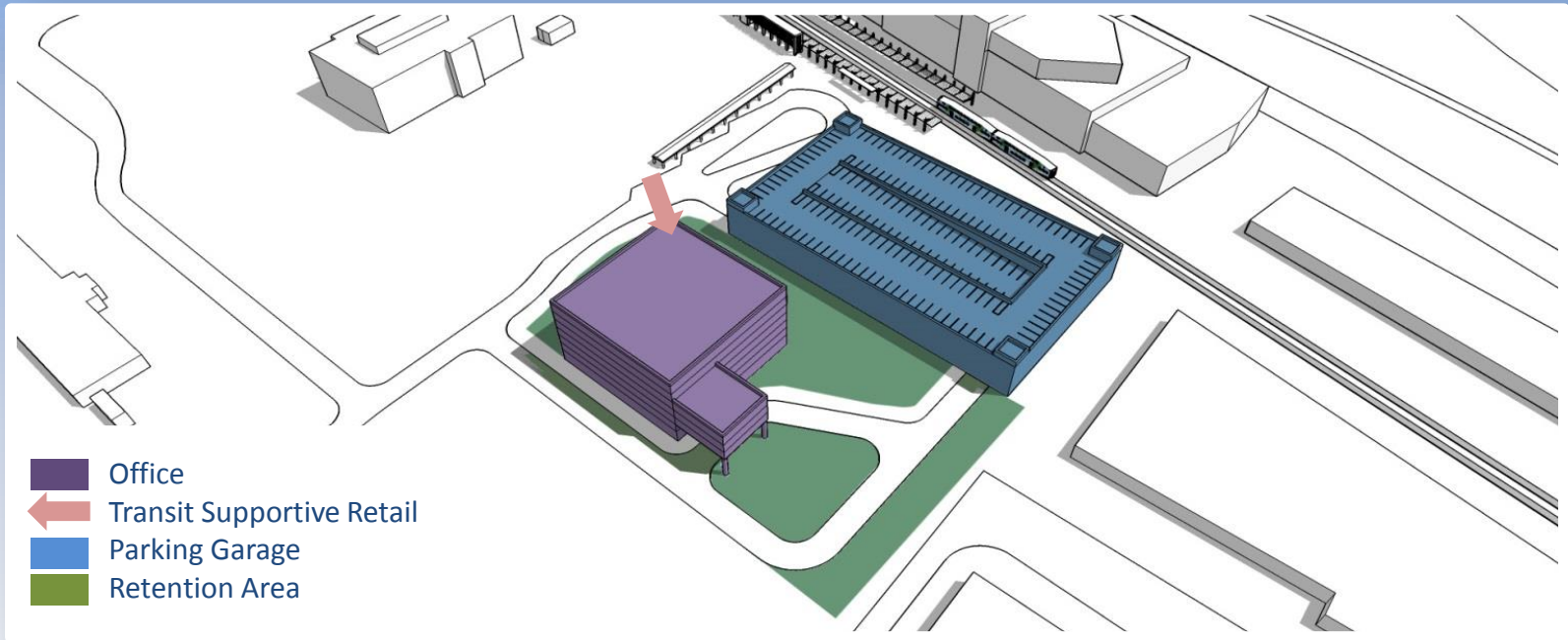

- Market Study calls for 150,000 sq.ft.
- Building Height – 7 floors
- 790 total spaces needed
 - ✓ Includes commuter and office demand
 - ✓ Assumes 10% shared parking reduction

Alternate Development Options: Hotel

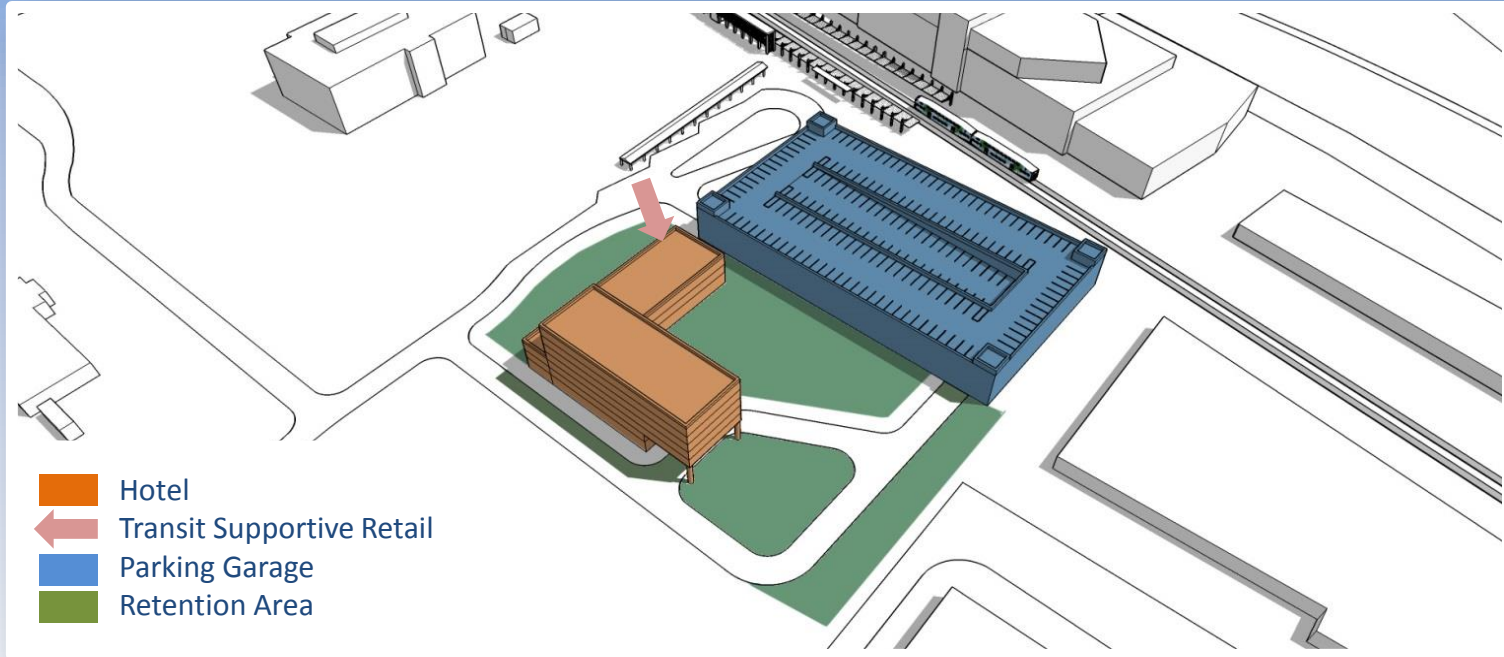

- Market Study calls for 150 rooms
- Building Height – 7 floors
- 350 total spaces needed
 - ✓ Includes commuter and hotel demand
 - ✓ Assumes 30% shared parking reduction

Next Steps

- May: - Refined site concept(s), evaluation
 - Public realm investment concepts / costs
- June: Concept illustrations
 (preferred site plan and streetscape elements)
- July: Development strategies
 (phasing, funding, plan/zoning amendments, partnerships, etc...)
- Aug/Sept: Finalize deliverables
 (reports, draft RFP elements)

Next Meeting

Friday, May 8

9:00am

Broward MPO Board Room